



Owner's Manual

ONE-PUMP (PU1) & TWO-PUMP (PU2)



OWNER'S INFORMATION

DEALER

Company _____
Address _____
Phone _____
E-mail _____

INSTALLER

Company _____
Address _____
Phone _____

SPA

Model (see below) _____
Serial Number (see below) _____
Color _____
Date of Delivery _____

For the model and serial numbers, locate the white plate to the right or left of the access panel, near the floor.

 Intertek 3126636	Roto Ops LLC Lake Mary, FL CONFORMS TO UL STD 1563		Volts:
			Amps:
			CirBrk:
			Hz:
Model No:			SN:
Options:			
Mfg Date:			
FOR INDOOR/OUTDOOR USE			Made In the USA

TABLE OF CONTENTS

IMPORTANT SAFETY INSTRUCTIONS.....	4-5
SELECTING ELECTRICAL MODE AND A LOCATION.....	6
SPA COVER INSTALLATION.....	7
FILLING YOUR SPA.....	8
DRAINING YOUR SPA.....	8
FOR THE ELECTRICIAN, TWO-PUMP, PU2 MODELS.....	9-11
FOR THE ELECTRICIAN, ONE-PUMP, PU1, MODELS, CONVERT HEATER TO 240VOLT.....	12-14
SYSTEM OPERATION ONE-PUMP, PU1 MODELS.....	15-16
SYSTEM OPERATION TWO-PUMP, PU2 MODELS.....	17-18
DISPLAY MESSAGES.....	19
SKIMMER-FILTER, CLEANING OR REPLACEMENT OF THE FILTER CARTRIDGE.....	20
AIR INJECTOR VENTURI ADJUSTMENT.....	21
ADJUSTABLE WATER FLOW JETS.....	21
WATERFALL FLOW ADJUSTMENT.....	21
WATER CHEMISTRY.....	22-23
REPLACING THE LED LIGHT.....	24
HEADREST INSTALLATION.....	25
FREEZE PROTECTION.....	26
CLEANING YOUR SPA.....	26
CARE FOR THE WEATHERSHIELD COVER	26
FREQUENTLY ASKED QUESTIONS.....	27
PURGING THE PUMP.....	28
TROUBLESHOOTING GUIDE.....	29
GLOSSARY OF TERMS.....	30
OZONE (OPTIONAL EQUIPMENT).....	31

Important Safety Instructions

When installing and using this electrical equipment, basic safety precautions should always be followed, including the following:

READ AND FOLLOW ALL INSTRUCTIONS

1. **WARNING:** To reduce the risk of injury, do not permit children to use this product unless they are closely supervised at all times.
2. **WARNING:** A wire connector is provided on this unit to connect a minimum 6 AWG (4.11 mm) solid copper conductor between this unit and any metal equipment, metal enclosures of electrical equipment, metal water pipe, or conduit within 5 feet (1.5m) of the unit.
3. **DANGER RISK OF INJURY:** (For cord and plug connected units):
 - a. Replace damaged cord immediately
 - b. Do not bury cord
 - c. Connect to a grounded, grounding type receptacle only.
4. **WARNING:** (For units with a Ground Fault Circuit Interrupter (GFCI): This product is provided with a Ground Fault Circuit Interrupter GFCI on the end of the spa's power cord. This GFCI must be tested before each use. With the product operating depress the "test" button on the GFCI the spa should not operate. Depress the "reset" button on the GFCI. The product should now operate normally. If the spa fails to operate in this manner, there is a ground current flowing indicating a possible electric shock. Disconnect the power until the fault has been identified and corrected by a certified licensed electrician.
5. **WARNING:** (For permanently installed units):

The electrical supply for this product must include a suitably rated switch or circuit breaker to open all ungrounded supply conductors to comply with Section 442-20 of the National Electric Code. ANSI / NFPA 70-1987. In addition, all 230-volt installations must be protected by a 230-volt Ground Fault Circuit Interrupter GFCI. Any GFCI circuit breaker used in the house panel must read current returning through the neutral conductor. 230-volt 2 conductor GFCI circuit breakers will not operate correctly for your application.
6. **DANGER RISK OF ACCIDENTAL DROWNING:** Extreme caution must be exercised to prevent unauthorized access by children. To avoid accidents, ensure that they cannot use this spa unless they are supervised at all times. For additional protection, use a cover which is classified by the Underwriters Laboratories meeting ASTM F1346-91 requirements. The cover supplied by the manufacturer meets these requirements.
7. **DANGER RISK OF INJURY:** If your spa is equipped with suction fittings, the suction fittings in this spa are sized to match the specific water flow created by the pump. Should the need arise to replace the suction fittings or the pump, be sure that the flow rates are compatible. Never operate spa if suction fittings are broken or missing. Never replace a suction fitting with one less than the flow rate marked on the original suction fitting.
8. **DANGER RISK OF ELECTRIC SHOCK:** Install at least 5 feet (1.5m) from all metal surfaces. As an alternative, a spa may be installed within 5 feet (1.5m) of metal surfaces if each metal surface is permanently connected by a minimum 6 AWG (4.11 mm) solid copper conductor to the wire connector on the terminal box that is provided for this purpose.
9. **DANGER RISK OF ELECTRIC SHOCK:** Do not permit any electric appliance, such as light, telephone, radio, or television, within 5 feet (1.5m) of a spa.
10. **WARNING TO REDUCE THE RISK OF INJURY:**
 - a. The water in a spa should never exceed 104°F (40°C). Water temperatures between 100°F (38°C) and 104°F (40°C) are considered safe for a healthy adult. Lower water temperatures are recommended for your children and when spa use exceeds 10 minutes.
 - b. Since excessive water temperatures have high potential for fetal damage during the early months of pregnancy, pregnant or possibly pregnant women should limit spa water temperatures to 100°F (38°C).
 - c. Before entering spa, the user should measure the water temperature with an accurate thermometer since the tolerances of water temperature-regulating devices vary.
 - d. The use of alcohol, drugs, or medication before or during spa use may lead to unconsciousness with the possibility of drowning.
 - e. Persons suffering from obesity or with a medical history of heart disease, low or high blood pressure, circulatory system problems, or diabetes should consult a physician before using a spa.
 - f. Persons using medication should consult a physician before using a spa since some medication may induce drowsiness while other medication may affect heart rate, blood pressure, and circulation.
11. **WARNING:**
 - a. People with infectious diseases should not use a spa or hot tub.
 - b. To avoid injury, exercise care when entering or exiting a spa or hot tub.
 - c. Do not use a spa or hot tub immediately following strenuous exercise.
 - d. Prolonged immersion in a spa or hot tub may be injurious to your health.

(Safety instructions continued on next page)

12. **Caution:** Maintain water chemistry in accordance to manufacturer's instructions.
Your spa can be a source of great pleasure. It offers healthful stimulating recreation and is a delightful fun center for you, your family and friends. However, it contains large quantities of water and is deep enough to present inherent dangers to life and health unless the following safety rules are strictly observed.
13. **Never permit the spa to be used unless it is attended by at least one person other than the bather.**
Someone should be present to lend assistance if the bather should be in trouble due to injuries, cramps, or drowning, especially in case of children.
14. **Always use care in and around your spa.**
The spa has many rigid, unyielding parts and many areas that become wet and slippery; these are all potentially dangerous when rough play is permitted or if care is not used, particularly when entering or leaving the spa.
15. **Keep the water sanitary and healthful at all times.**
Your filter system will remove suspended particles from the water. Regular application of spa chemicals in proper quantities will destroy harmful bacteria and prevent formation of algae. Your surface skimmer will remove insects, leaves, and other debris from the water surface. Unsanitary water is a serious health hazard.
16. **The water in your spa must NOT be warmer than 100°- 104° F (38°-40°C).**
Always keep an accurate thermometer in the water because your spa's thermostat may be in error. Use a high quality, shatterproof thermometer with increments of one degree or less.
The National Spa and Pool Institute consider a temperature of 100°F (38°C) safe and comfortable for a healthy adult. Most healthy adults can enjoy this water temperature for as long as desired, although it may raise the body temperature to the water temperature and eventually become uncomfortable (like a fever). At higher water temperatures the soaking time should be shorter; never soak for more than 20 minutes when the water temperature is 102°F (39°C) or higher. If you are planning a long rest in the spa, lower the water temperature closer to normal body temperature, about 99°F (37.2°C). Some people find even lower water temperatures relaxing and pleasing. Try different water temperatures in the 98°-102°F (36.6°-39°C) range until you find what temperatures suit you best.
17. **Hot water can raise the body temperature high enough to cause heat stroke.**
This can be fatal even to healthy adults. If you have any questions about your own fitness or whether you should soak in the spa, check with your physician.
18. **Prolonged immersion in hot water may induce hyperthermia.**
Hyperthermia occurs when internal body temperature reaches a level several degrees above the normal body temperature of 98.6°F (36.6°C). The symptoms of hyperthermia include: (1) dizziness, (2) fainting, (3) drowsiness, (4) lethargy, (5) increases in the internal body temperature. The effects of hyperthermia include: (1) unawareness of impending hazard, (2) failure to perceive heat, (3) failure to recognize the need to exit spa, (4) physical inability to exit spa, (5) unconsciousness resulting in danger of drowning.
19. **WARNING: The use of alcohol, drugs, or medication can greatly increase the risk of fatal hyperthermia in hot tubs or spas.**
Despite the popular image of people in spas drinking wine or other alcoholic beverages, DO NOT use alcoholic beverages before or during spa use. Alcohol is a depressant which causes slowed reflexes and drowsiness, especially in conjunction with the relaxed soaking in hot water. This can lead to sleep or unconsciousness and possibly result in drowning. Using your spa with other people who are also drinking is not a preventative measure since they are likely to become similarly affected by the combinations of alcohol and hot water soaking.
Soaking in hot water causes changes in the circulatory system, such as enlargement of blood vessels near the skin. Therefore, people with a medical history of heart disease, circulatory problems, diabetes, high or low blood pressure should check with their physician before using spas. Additionally, people taking medications causing drowsiness, such as tranquilizers, narcotics, antihistamines, or anticoagulants should not use spas without asking their physician.
20. **If equipped, broken or missing drain covers should be replaced immediately.**
Accidents can occur when long hair or a body part is trapped by suction from a drain or outlet whose cover is broken or removed. Children are particularly vulnerable, and they should be warned against danger.
21. **WARNING:** Do not use electrical appliances in or around your spa. Do not use glass or other breakable items in or around your spa. Do not remove spa cabinet panels and attempt to make repairs. Do not attempt electrical repairs. Retain a certified licensed electrician.
22. **This spa is for residential use only.** It is not intended for commercial use.

SAVE THESE INSTRUCTIONS

Selecting electrical mode and a location

WARNING! DO NOT STORE SPAS OUTDOORS WITHOUT PROPER WATER LEVEL.

A spa stored outside in direct sun, without proper water level, uncovered or under a tarp/cover, can accumulated temperatures that will damage the spa, its components and void the warranty. Only store an empty spa indoors or in the shade.

One-pump (PU1) models

Will you operate the spa on 120- or 240-volts heater?

Your spa comes ready to plug into a standard 120 volt / 15-amp outlet for power. However, the heater can be converted from 120-volt 1000 watts, to 240 volt 4000 watts, with a hard-wired power supply installed by a licensed certified electrician. Please read the following to help with your decision.

120 volts: When connected with the 120-volt plug, the heater is 1000 watts and operates only in the low speed filtration mode. When the jet pump operates, the heater will turn off. This means the water will begin to cool while using the jet pump and the heat recovery time will take longer than it will if wired 240 volts. Many find this adequate due to their mild climate or shorter length of usage. Additionally, many prefer not to hire an electrician for the installation.

240 volts: When hard-wired to a 240-volt power supply, the heater is 4000 watts. It can operate on a 30- or 40-amp service.

On a 30-amp service the heater will not operate with the jet pump. However, the higher heater wattage will greatly increase the heat recovery time. The 30-amp circuit is often selected when there is limited available power as seen in some older homes.

On a 40-amp service the heater will operate with both high and low speed. This means the spa will heat while you operate the jet pump.

If you have decided to operate your spa on 120 volts, will your electrical cord reach an outlet?

Locate your spa so that the GFCI plug and cord will reach a standard 120 volt / 15-amp outlet*, but not closer than 5 feet (1.5m). Do not use an extension cord. Use of an extension cord will void your warranty. To extend the power cord, with a Philips screwdriver remove the access panel, locate the coiled GFCI cord, uncoil and extend the cord. Ensure that the cord is routed through the notch at the lower center of the opening before reinstalling the access panel. Do not connect to the outlet until the spa is filled with water (see page 8).

If you have decided to convert your spa to 240 volts, a certified licensed electrician is required for the electrical installation. In this case, you may want to consult with your electrician before final positioning of your spa. Have your electrician see pages 12-14 for conversion instructions.

Two-pump (PU2) models:

Electrical power supply: a certified licensed electrician is required for the electrical installation. You may want to consult with your electrician before final positioning of your spa. Have your electrician see pages 9-11 for more information.

Is permitting required for construction, electrical, or barriers?

Most cities and counties require permits for exterior construction and electrical circuits. Some areas have codes requiring barriers such as fencing and/or self-closing gates on property to prevent unsupervised access to the property by children. Your local code enforcement department can provide information on which permits may be required and how to obtain them before delivery of your spa.

Is the support surface adequate to support the weight of the spa?

Provide a solid flat level load-bearing surface. The surface must provide a solid foundation with a minimum load bearing capacity of 160 pounds per square foot (784 kg per square meter). Concrete slabs and decks must be designed to support this weight.

Warning! Your spa is constructed of a very resilient and flexible polymeric material. It is designed to flex as much as 2 inches (5cm) without damage. However, overfilling the spa and/or installing on a non-level surface for extended periods of time can permanently distort the original shape of your spa, cause structural damage, effect the sealing of the cover and void your warranty.

Is the support surface impervious to water and adequate to handle water overflow?

The surface must be suitable for a wet location and allow for adequate drainage for overflow water.

Are there considerations for limiting access by children?

Childproof Your Spa. Plan for limiting access by children. Take precautions such as self-closing, locking gates, access panels, fencing and other child barriers, as dictated by the site.

Are there overhead electrical lines?

Do not locate your spa under overhead power lines or in near proximity to existing buried or exposed electrical circuits.

Is there adequate room to access the service panel, drain, filter and insulating cover removal?

If you are installing your spa near a wall or with any type of structure on the outside, such as a gazebo, remember to allow access for service and insulating cover removal.

Are there any privacy considerations?

*To avoid nuisance circuit breaker tripping, it is best to use an outlet on a circuit which does not supply power to any other major running appliance. This can be checked by turning off the circuit breaker that supplies the intended outlet and verifying that no other electrical devices no longer work, such as a refrigerator, dishwasher, washing machine, coffee maker, hair dryer, etc.

Spa Cover Installation

WARNING! AVOID DROWNING RISK

- Failure to follow instructions may result in injury or drowning.
- Non-secured covers are a hazard.
- Keep children away. People or objects cannot be seen under the cover.
- Because of entrapment possibility, remove cover completely before entry of bathers.
- Excess weight can break the insulating foam, bend the steel reinforcement and damage the cover. Do not allow people or pets to stand or sit on the cover. Do not allow loads such as snow, leaves or anything else to accumulate on the cover. Do not use the cover as a table.

Caution, to avoid damage to the cover always remove the cover while adding chemicals to the spa water. This will prevent damaging chemical vapors from being trapped under the spa cover. These vapors can prematurely damage the cover material and void the warranty.

When properly installed, the cover supplied with your spa meets the Manual Safety Cover requirements of ASTM F1346-91.

If you are installing your spa near a wall or with any type of structure on the outside, such as a gazebo, remember to allow access for cover removal.

To deter entrapment by somebody slipping under the cover, ensure that all latches supplied with the cover are securely screwed to the cabinet, straps are inserted into the latches, the latches are locked, and the key is kept in a secure location.

Keep the spa covered when not in use to deter entry by unauthorized persons, reduce the loss of heat, and keep out rain and to keep foreign materials from settling in the water.

Follow these steps to properly install the cover.

1. Place the spa cover on top of the spa. Ensure the cover flaps and straps are not under the cover. Ensure the cover is properly seated in its final position.
2. Each strap is supplied with a cabinet latch snapped in place. Leave the cabinet latches at the end of the straps, but remove the bag containing the screws and while lightly pulling downward on a strap, mark the center bottom of the latch (fig 1). A piece of tape may be a good method to do this. Mark each remaining strap in the same way.
3. Remove the strap by pinching the two barbs of the strap as indicated (fig 2).
4. Hold the cabinet latch on the mark and using a Phillips screwdriver, drive three screws through the holes in the cabinet latch and into the outside of the spa (fig 3).
5. While the spa is not in use place the cover on top of the spa and snap all straps into the cabinet latches. To further protect against entry, lock each latch by quarter turning the key clockwise (fig 4). Store the key in a secure place.

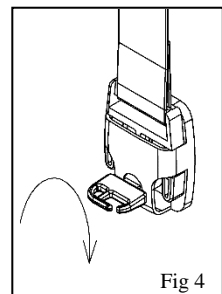
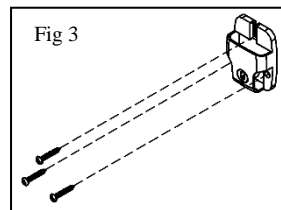
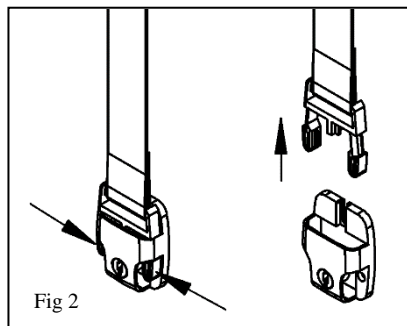
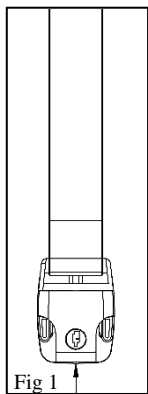

Filling Your Spa

Warning! Your spa is constructed of a very resilient and flexible polymeric material. It is designed to flex as much as 2 inches (5cm) without damage. However, overfilling the spa and/or installing on a non-level surface for extended periods of time can permanently distort the original shape of your spa, cause structural damage, effect the sealing of the cover and void your warranty.

Remove the access panel and ensure the drain valve is closed and the cap is secure (Fig 5).

Place a garden hose into filter area (Fig 7) and fill the spa with cold (never warm or hot) water 6 to 8 inches (15 to 20 cm) below the top edge of the spa (Fig 6). If there is not enough water in your spa, the pump may suck air into the plumbing system thereby damaging the pump or heater and void the warranty. Do not overfill, as the spa's water level will rise as each person enters the spa. Always keep the spa water level above the jet openings.

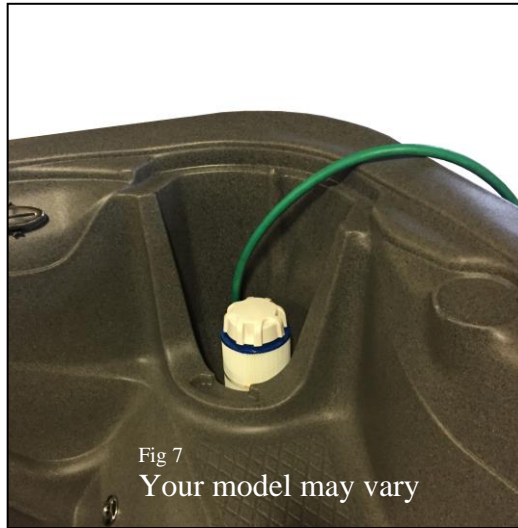
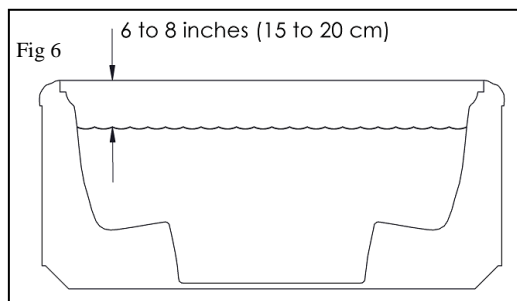
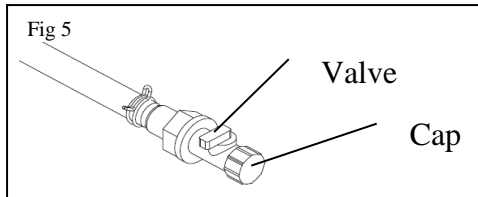

Draining the spa

Draining your spa on a regular basis rids the spa of dissolved solids and protects your spa equipment from the effects of residual calcium hardness and total alkalinity problems. Depending upon usage, it may be as often as every three months.

To drain the spa, follow these steps:

1. Turn power off to the spa.
2. Remove the access panel and locate the drain valve (Fig 5).
3. Ensure that the drain valve is in the off position (as shown in Fig 5). Remove the cap (Fig 5) and attach a standard garden hose to the drain valve (Fig 8).

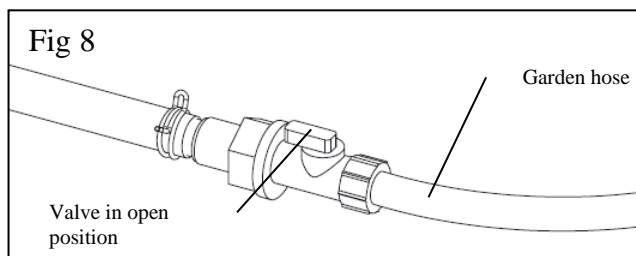

4. Route the garden hose to a sewer drain capable of safely assimilating 300 plus gallons (1135 liters) of water which may contain both unsanitary contaminants and chemical residue. Open the drain valve (as shown in Fig 8). The spa drains slowly.
5. The spa can only drain to the lowest jet. It may be necessary to manually remove the remaining water.
6. Before refilling your spa, ensure that the drain valve is in the off position and the cap is secured (Fig 5).

Two-pump (PU2) models, FOR THE ELECTRICIAN

Installations that do not adhere to these instructions can expose users to electric shock and will void the warranty.

Power Requirements

240VAC, 60HZ, 50A, Class A GFCI-protected service (Circuit Breaker rating 50A).

4 wires (hot, hot, neutral, ground).

GFCI PROTECTION: The new service must be protected with by a GFCI and a disconnect switch. The National Electrical Code requires that spas connected to 240 volts circuits be equipped with a GFCI and disconnect switch. See National Electric Code Articles 680-12 and 680-42. This spa is not equipped with a 240-volt GFCI or a disconnect switch. A GFCI must be installed by a certified licensed electrician.

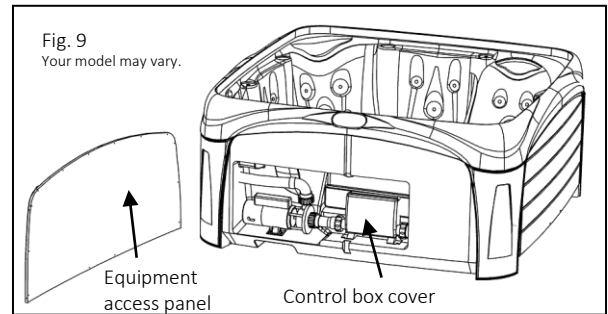

OUTDOOR LOAD CENTER: The addition of an outdoor load center such as a Siemens W0408ML 1125 or equal must be added to the circuit. This type of load center provides both a GFCI and Disconnect Switch in a convenient configuration as required by the National Electric Code. (See next page for suggested wiring configuration)

ISOLATED, DEDICATED 240 VOLT, 50 AMP CIRCUIT IS REQUIRED An isolated, dedicated 240-volt 50-amp circuit is required to provide the power necessary to properly operate the 240V equipment package.

PERMANENTLY HARD WIRED: All 240-volt operations wiring must be permanently hard wired, installed in grounded conduit and installed in compliance with the National Electrical Code and all local codes. Do not use an extension cord. Use of an extension cord will void the warranty.

WIRE SIZING MUST MEET ELECTRICAL CODES: All installations are different. Wire sizing must meet the National Electrical Code and all local code specifications.

To make electrical connections, remove the access panel as shown in Fig 9. Locate the control box, remove the cover and make connections.

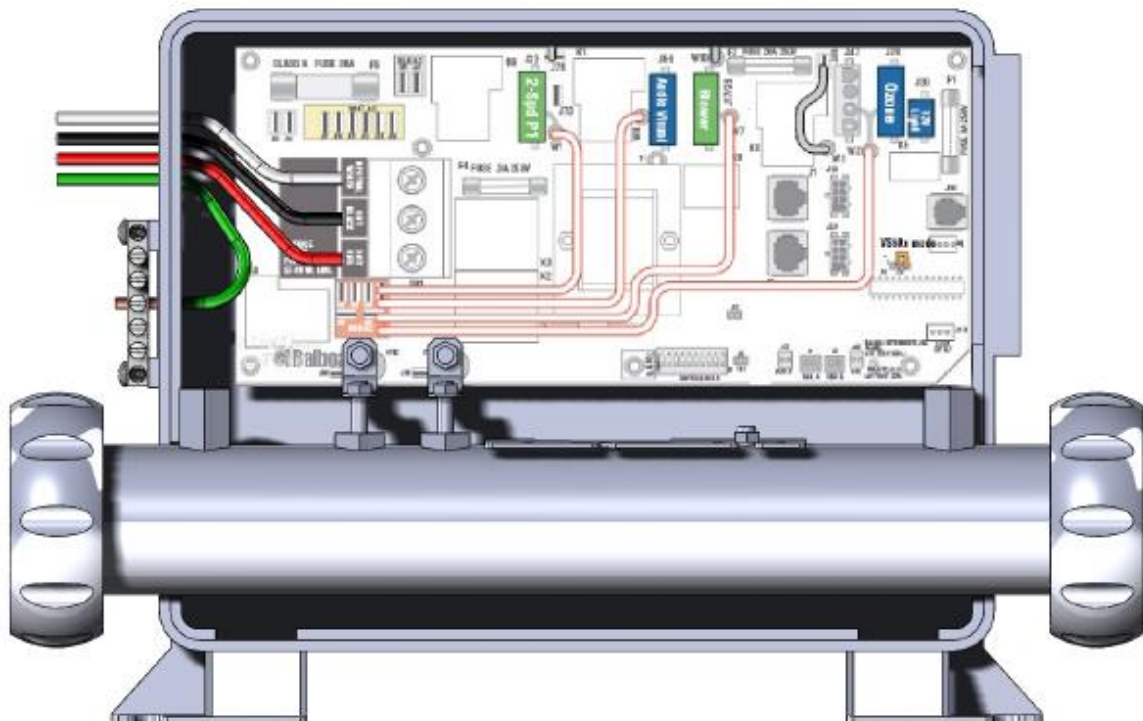

See next two pages for more electrical details

**Two-pump (PU2) models, FOR THE ELECTRICIAN continued
ELECTRICAL DATA FOR THE USE OF CERTIFIED LICENSED ELECTRICIAN
REQUIRED WIRING FOR 240 VOLT 4 WIRE INSTALLATION**

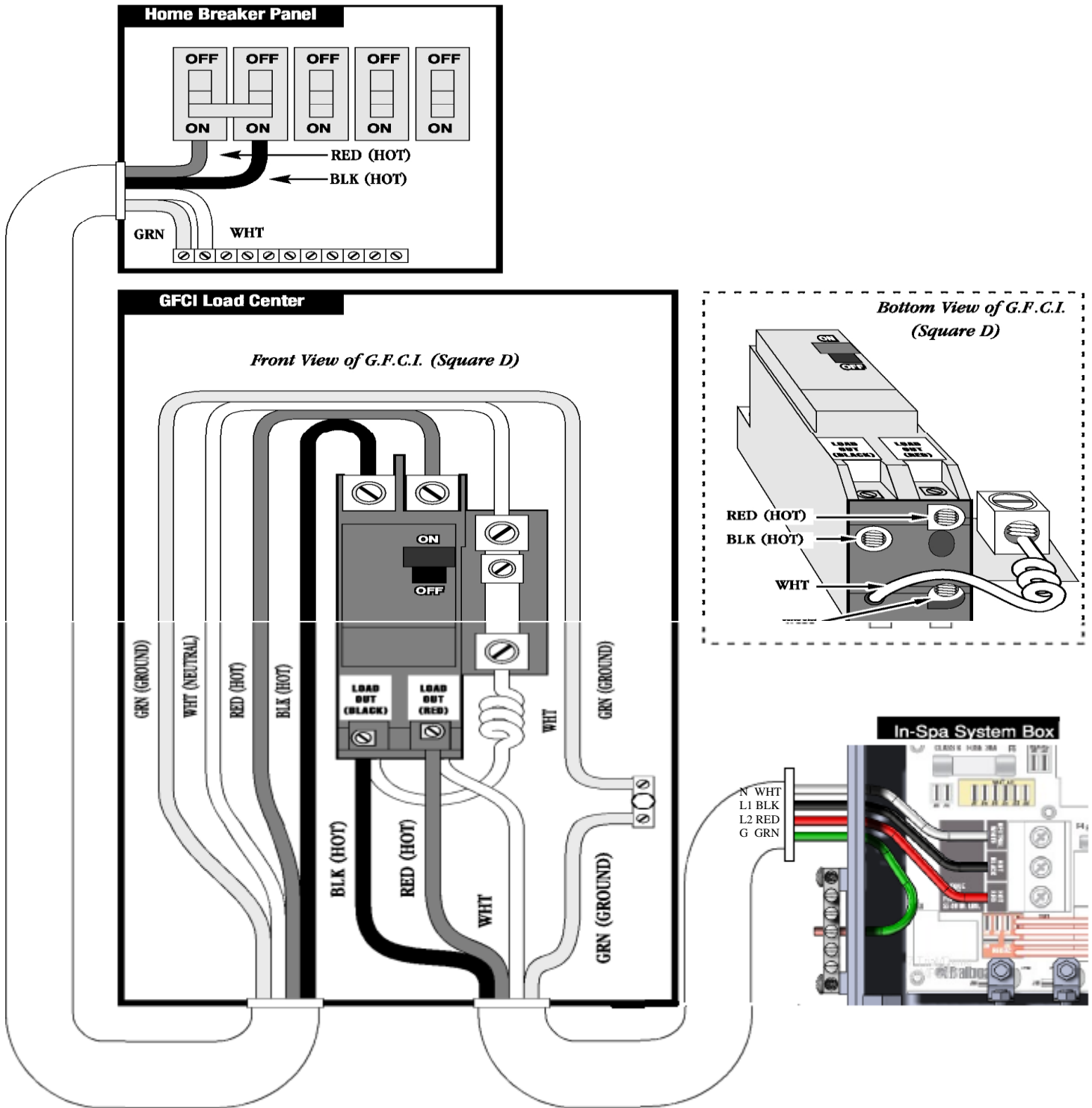

WARNING: Shock Hazard! Under No Circumstances Should This Spa Be Installed by Anyone Other Than A Certified Licensed Electrician!

Two-pump (PU2) models, FOR THE ELECTRICIAN continued

DIP SETTINGS VS501Z, 54379-03, Setup 2

MAIN POWER TO SYSTEM MUST BE TURNED OFF BEFORE ADJUSTING DIP SWITCHES

<p>DIP SETTINGS</p> 	TEST MODE OFF	← 1	TEST MODE ON
	STD, ECON, SLEEP ALLOWED	2 →	STANDARD MODE ONLY
	DUPLEX PANEL	3 →	MINI PANEL
	N/A MUST BE OFF	← 4	N/A MUST BE OFF
	N/A MUST BE OFF	← 5	N/A MUST BE OFF
	60HZ OPERATION	← 6	50HZ OPERATION
	TWO PUMPS	← 7	ONE PUMP
	DEGREES FAHRENHEIT	← 8	DEGREES CELSIUS
	N/A MUST BE OFF	← 9	N/A MUST BE OFF
	HIGH AMP – HEAT W/P1 HI	← 10	LOW AMP – NO HEAT W/P1 HI

One-pump (PU1) models

FOR THE ELECTRICIAN, CONVERSION FROM 120V TO 240V

Installations that do not adhere to these instructions can expose users to electric shock and will void the warranty.

The conversion of the equipment package, from a factory installed 120-volt system to a hardwired 120/240-volt system, must be completed by a certified licensed electrician. This procedure will convert the heater from 120 volts (1000 watts) to 240 volts (4000 watts). All other electrical components will remain 120 volts, so it will be necessary to include a neutral wire in the new electrical service. It will also be necessary to select how the heater will operate, thereby dictating the size of the new electrical service. If the heater will operate only when the low-speed pump is running, then a 30-amp service will be used, and the #10 dip switch will be set to the **low amp** position (page 14). If the heater will operate when both high and low-speed pumps are running, then a 40-amp service is required, and the #10 dip switch will be set in the **high amp** position (page 14). Regardless of your choice, the following will also have to be done.

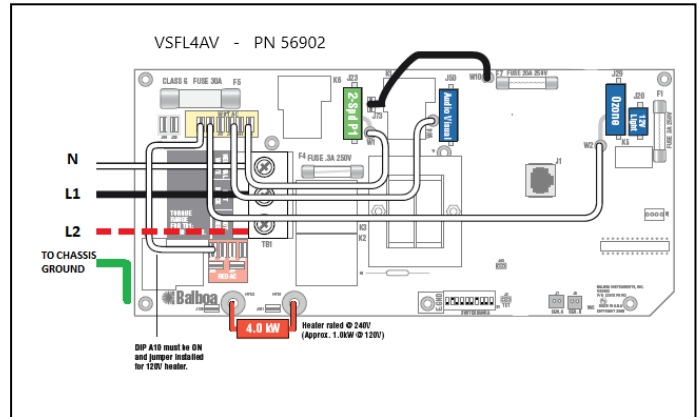

1. Remove and discard the 120-volt GFCI power cord.
2. Remove and discard the white wire jumper between J32 and J11.
3. Move #10 dip switch to proper position: low amp for a 30-amp service, or high amp for a 40-amp service. See page 6 to help with the decision.
4. When supplying the new 4 wire service, connect line 2 to the terminal indicated by the dotted line in the above diagram.

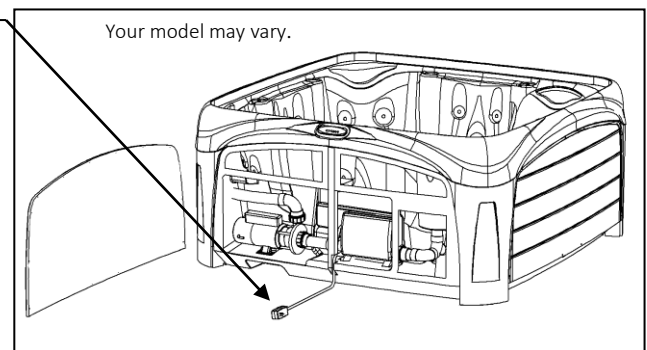

Additional wiring information:

GFCI PROTECTION: The new service must be protected with by a GFCI and a disconnect switch. The National Electrical Code requires that spas connected to 240 volts circuits be equipped with a GFCI and disconnect switch. See National Electric Code Articles 680-12 and 680-42. This spa is not equipped with a 240-volt GFCI or a disconnect switch. A GFCI must be installed by a certified licensed electrician.

OUTDOOR LOAD CENTER: The addition of an outdoor load center such as a Siemens W0408ML 1125 or equal must be added to the circuit. This type of load center provides both a GFCI and Disconnect Switch in a convenient configuration as required by the National Electric Code. (See next page for suggested wiring configuration)

ISOLATED, DEDICATED 240 VOLT, 30- OR 40-AMP CIRCUITS ARE REQUIRED An isolated, dedicated 240 volts, 30- or 40-amp circuit is required to provide the power necessary to properly operate the 240V equipment package.

PERMANENTLY HARD WIRED: All 240-volt operations wiring must be permanently hard wired, installed in grounded conduit and installed in compliance with the National Electrical Code and all local codes. Do not use an extension cord. Use of an extension cord will void the warranty.

WIRE SIZING MUST MEET ELECTRICAL CODES: All installations are different. Wire sizing must meet the National Electrical Code and all local code specifications.

See next two pages for more conversion details

One-pump (PU1) models

FOR THE ELECTRICIAN, CONVERSION FROM 120V TO 240V continued
 ELECTRICAL DATA FOR THE USE OF CERTIFIED LICENSED ELECTRICIAN
 REQUIRED WIRING FOR 240 VOLT INSTALLATION

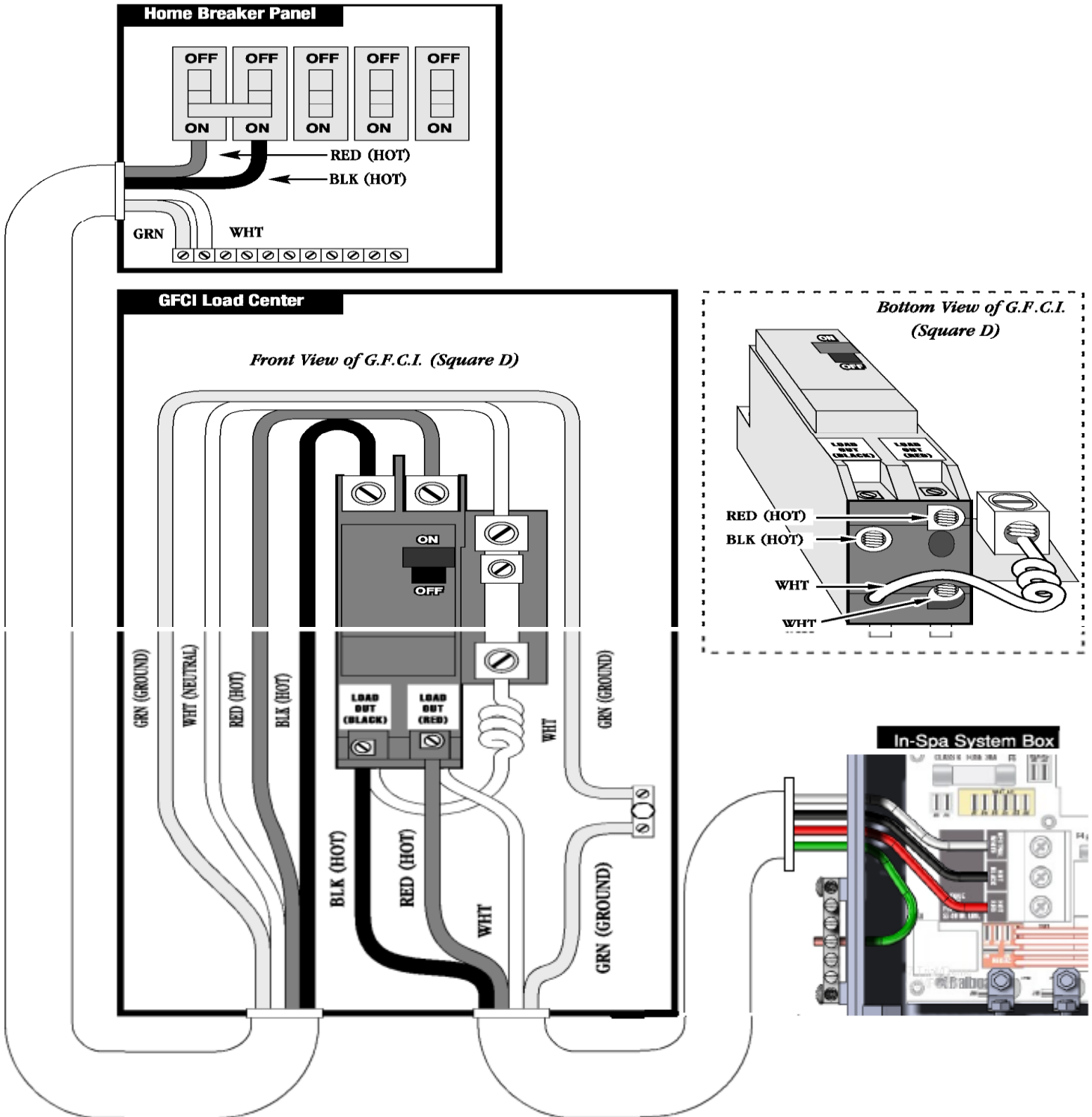

WARNING: Shock Hazard! Under No Circumstances Should This Spa Be Installed By Anyone Other Than A Certified Licensed Electrician!

All wiring MUST be in accordance with the National Electrical Code and all local codes

One-pump (PU1) models FOR THE ELECTRICIAN, CONVERSION FROM 120V TO 240V
continued

DIP SETTINGS VS3FL4AV 56902

MAIN POWER TO SYSTEM MUST BE TURNED OFF BEFORE ADJUSTING DIP SWITCHES

<p>DIP SETTINGS</p> 	TEST MODE OFF	← 1	TEST MODE ON
	N/A MUST BE OFF	2 →	JET/LIGHT/TEMP DOWN/TEMP UP
	LT DUP OR DIGDUP PANEL	3 →	MINI PANEL
	N/A MUST BE OFF	← 4	N/A MUST BE OFF
	SEE PUMP TABLE	← 5	SEE PUMP TABLE
	60HZ OPERATION	← 6	50HZ OPERATION
	STD, ECON, SLEEP ALLOWED	7 →	STANDARD MODE ONLY
	DEGREES FAHRENHEIT	← 8	DEGREES CELSIUS
	SEE PUMP TABLE	← 9	SEE PUMP TABLE
	HIGH AMP – HEAT W/P1 HI	10 →	LOW AMP – NO HEAT W/P1 HI

PUMP TIMEOUTS TABLE

<u>Switch 5</u>	<u>Switch 9</u>	<u>Low speed</u>	<u>High speed</u>
<u>Off</u>	<u>Off</u>	<u>2 Hours</u>	<u>15 Minutes</u>
<u>On</u>	<u>off</u>	<u>2 Hours</u>	<u>30 Minutes</u>
<u>Off</u>	<u>On</u>	<u>15 Minutes</u>	<u>15 Minutes</u>
<u>on</u>	<u>On</u>	<u>30 Minutes</u>	<u>30 Minutes</u>

One-pump (PU1) models, System Operation

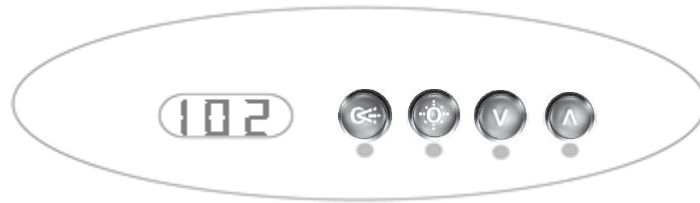



Initial Start-Up



When your Spa is first activated, it will perform a self-diagnostics test showing a series of numbers followed by Pr, then by --along with the low speed pump for approximately 7 minutes total. Also, the internal clock that keeps track of the filtration cycles every 12 hours will start at that point. The system is preset to heat up to 100° F (37° C) and it is also preset to run on low speed for one hours (F1). If after the first 7 minutes water is not flowing from the jets you may need to purge the pump. Please see page 28.

Temperature Adjustment



80° F-104° F (26°C-40° C)

The control's display will constantly show the spa's water temperature. To adjust the spa's water temperature, press  or . The display will flash and show the current temperature setting. Each time either one of these buttons are pressed, the temperature setting will change by 1°. After you have set the desired temperature, stop pressing the buttons, the display will stop flashing after five seconds and the current spa temperature will show again.

Jets

Press the  pad to power the pump. The pump will sequence with each press of the  pad as follows: low flow – high flow – off. If left running, the high flow pump will automatically turn off after 15 minutes (low flow in two hours). These time out durations can be adjusted. See page 14 for details.



Adjustable LED Light

To turn the light on, press the  button. Press again to turn it off. To adjust the color modes, press the  button immediately after turning it off. The light will come back on in a new color mode. Each time you repeat this procedure, the light will cycle to a new color mode, as shown below. If left on, the light will automatically turn off after four hours.

1. Color wheel. The light will slowly blend cycle through the colors.
2. Aqua white.
3. Light blue.
4. Violet.
5. Dark blue.
6. Light green.
7. Dark green.
8. Red.
9. Step sequence through the colors.
10. Very slow color wheel.
11. Back to #1.

Spa Water Maintenance

This function enables you to program the amount of water filtration time.

Press  or  then  to enter the programming mode.

Once in the programming mode press  or  to select the filtration time.

F1 In this mode the water will be filtered for 1 hour every 12 hours.

F2 In this mode the water will be filtered for 2 hours every 12 hours.

F3 In this mode the water will be filtered for 3 hours every 12 hours.

F4 In this mode the water will be filtered for 4 hours every 12 hours.

F5 In this mode the water will be filtered for 5 hours every 12 hours.

F6 In this mode the water will be filtered for 6 hours every 12 hours.

F7 In this mode the water will be filtered for 7 hours every 12 hours.

F8 In this mode the water will be filtered for 8 hours every 12 hours.

To exit press .

Spa heating modes

Your spa is factory set to Standard Heating (ST) mode. This mode operates the heater whenever needed to maintain the programmed spa water temperature. (See Temperature Adjustment page 15).

Advanced Optional Settings

You have the option to enable other heating modes as explained below: standard, economy and sleep. To enable these heating modes, you must do the following steps.

1. Turn off power to the spa.
2. Using a Philips screwdriver, remove the equipment access panel as shown.
3. Remove the control box cover by removing the two bottom screws, slide the cover up and then pull forward.
4. Slide dip switch 7 to the *off* position. See page 14 for reference.
5. Reinstall the control box cover and the equipment access panel, before turning the power on.

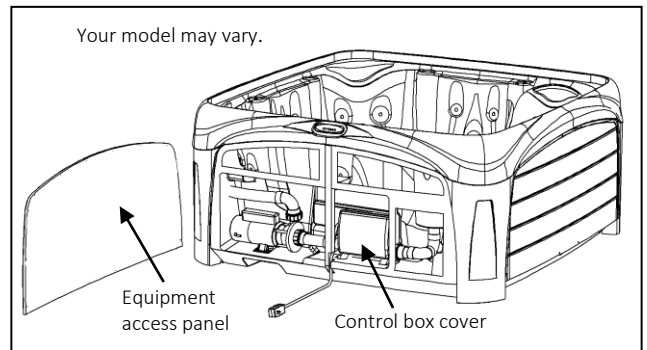

These heating modes offer the ability to control your heater in one of three ways: standard, economy or sleep. Your spa is preset at the factory to Standard Mode. However, the Standard Heating Mode can be changed to Economy or Sleep by pressing then . With each pressing of then , the display will cycle through the three different modes described below. Note: by pressing then , you will not see the heating mode the spa is currently set to, but rather it will advance to the next mode. It is the last mode seen in the display that will be the new heating mode setting.

- **Standard Mode (St):** Your spa is preset to this mode. This mode operates the heater whenever needed to maintain the programmed spa water temperature. (See Temperature Adjustment page 15).
- **Economy Mode (Ec):** This mode operates the heater only during programmed Filtering Cycles (See Spa Water Filtration Settings above). This mode is ideal for areas that charge a premium for electricity during peak hours. This mode will maintain the thermostat setting. If it does not reach the thermostat setting, you may have to allow for more heating time by increasing the filtration cycles.
- **Sleep Mode (SL):** This mode works in the same manner as the Economy Mode except the thermostat setting is automatically lowered by 20 degrees. This mode is best suited for extended leaves from home when it is not important to maintain constant water temperature, such as vacations or business trips.

Summer Set Temperature

In extremely hot weather, it is possible for water temperature to exceed the temperature setting. This is especially common when your temperature setting is lower than air temperature. If the water temperature exceeds the temperature setting more than 3°F (1.5°C), the pump will stop running automatically except during filter cycles. Normal operation will resume when the water temperature cools to below the setting, or the setting is increased above the water temperature.

Two-pump (PU2) models, System Operation

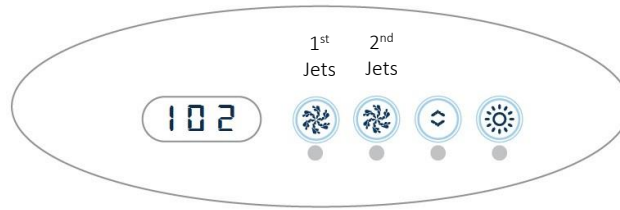





Initial Start-Up

When your spa is first activated, it will perform a self-diagnostics test showing a series of numbers followed by Pr, then by -- along with the low speed pump for approximately 7 minutes total. Also, the internal clock that keeps track of the filtration cycles every 12 hours will start at that point. The system is preset to heat up to 100° F (37° C) and it is also preset to run on low speed for two hours (F2). If after the first 7 minutes water is not flowing from the jets you may need to purge the pump. Please see page 28.

Temperature Adjustment



80° F-104° F (26°C-40° C)

The control's display will constantly show the spa's water temperature. To adjust the spa's water temperature, press the  button. The display will show the current set temperature and flash. To change the set temperature, press the  button a second time before the display stops flashing. Each press of the  button will continue to either raise or lower the set temperature. If the opposite direction is desired, allow the display to revert to the current water temperature. Press the  button to display the set temperature, and again to make the temperature change in the desired direction. After you have set the desired temperature, stop pressing the  button, the display will stop flashing after five seconds and the current spa temperature will show again.



1st Jets

Press the 1st jets  button to power the 1st jet pump. Press again to turn it off. If left running, the high flow pump will automatically turn off after 15 minutes.

2nd Jets

Press the 2nd jets  button to power 2nd jet pump. This pump will sequence with each press of the 2nd jets  button as follows: low flow – high flow – off. If left running, the high flow pump will automatically turn off after 15 minutes (low flow in 4 hours).

Adjustable LED Light

To turn the light on, press the  button. Press again to turn it off. To adjust the color modes, press the  button immediately after turning it off. The light will come back on in a new color mode. Each time you repeat this procedure, the light will cycle to a new color mode, as shown below. If left on, the light will automatically turn off after four hours.

12. Color wheel. The light will slowly blend cycle through the colors.
13. Aqua white.
14. Light blue.
15. Violet.
16. Dark blue.
17. Light green.
18. Dark green.
19. Red.
20. Step sequence through the colors.
21. Very slow color wheel.
22. Back to #1.

Two-pump (PU2) models, Additional Functions

Spa Water Maintenance

This function enables you to program the amount of water filtration time.

Press  then the 2nd jets  button to enter the programming mode.

Once in the programming mode press  to select the filtration time.

F2 In this mode the water will be filtered for 2 hours every 12 hours. This is the default mode as supply from factory.

F4 In this mode the water will be filtered for 4 hours every 12 hours.

F6 In this mode the water will be filtered for 6 hours every 12 hours.

F8 In this mode the water will be filtered for 8 hours every 12 hours.

FC In this mode the water will be filtered continuously.

To exit press the 2nd jets  button.

Spa heating modes





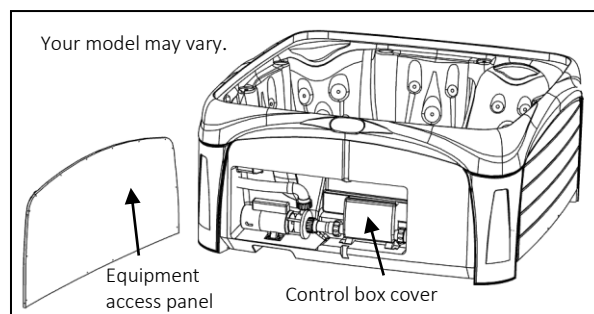

Your spa is factory set to Standard Heating (ST) mode. This mode operates the heater whenever needed to maintain the programmed spa water temperature. (See Temperature Adjustment page 17).

Advanced Optional Settings

You have the option to enable other heating modes as explained below: standard, economy and sleep. To enable these heating modes, you must do the following steps.

6. Turn off power to the spa.
7. Using a Philips screwdriver, remove the equipment access panel as shown.
8. Remove the control box cover by removing the two bottom screws, slide the cover up and then pull forward.
9. Slide dip switch 2 to the *off* position. See page 11 for reference.
10. Reinstall the control box cover and the equipment access panel, before turning the power on.



These heating modes offer the ability to control your heater in one of three ways: standard, economy or sleep. Your spa is preset at the factory to Standard Mode. However, the Standard Heating Mode can be changed to Economy or Sleep by pressing  then . With each pressing of  then , the display will cycle through the three different modes described below. Note: by pressing  then , you will not see the heating mode the spa is currently set to, but rather it will advance to the next mode. It is the last mode seen in the display that will be the new heating mode setting.

- **Standard Mode (St):** Your spa is preset to this mode. This mode operates the heater whenever needed to maintain the programmed spa water temperature. (See Temperature Adjustment page 17).
- **Economy Mode (Ec):** This mode operates the heater only during programmed Filtering Cycles (See Spa Water Filtration Settings above). This mode is ideal for areas that charge a premium for electricity during peak hours. This mode will maintain the thermostat setting. If it does not reach the thermostat setting, you may have to allow for more heating time by increasing the filtration cycles.
- **Sleep Mode (SL):** This mode works in the same manner as the Economy Mode except the thermostat setting is automatically lowered by 20 degrees. This mode is best suited for extended leaves from home when it is not important to maintain constant water temperature, such as vacations or business trips.

Summer Set Temperature

In extremely hot weather, it is possible for water temperature to exceed the temperature setting. This is especially common when your temperature setting is lower than air temperature. If the water temperature exceeds the temperature setting more than 3°F (1.5°C), the pump will stop running automatically except during filter cycles. Normal operation will resume when the water temperature cools to below the setting, or the setting is increased above the water temperature.

Display Messages

MESSAGE	MEANING	ACTION REQUIRED
	No message on display. Power has been cut off to the spa.	The control panel will be disabled until power returns. Spa settings will be preserved until next power up.
--	Temperature unknown.	After the pump has been running for one minute, the temperature will be displayed.
H H	Overheat -The spa has shut down. One of the sensors has detected 118°F (47°C) at the heater.	DO NOT ENTER THE WATER. Remove the spa cover and allow water to cool. Once the heater has cooled, reset by pushing any button. If spa does not reset, shut off the power to the spa and call your dealer or service organization.
O H	Overheat" -The spa has shut down. One of the sensors has detected that the spa water is 110°F (43°C).	DO NOT ENTER THE WATER. Remove the spa cover and allow water to cool. At 107°F (41°C), the spa should automatically reset. If spa does not reset, shut off the power to the spa and call your dealer or service organization
1 C	Ice -Potential freeze condition detected.	No action required. The pump will automatically activate regardless of spa status.
S A	Spa is shut down. The sensor that is plugged into the "A" jack is not working.	If the problem persists, contact your dealer or service organization. (May appear temporarily in an overheat situation and disappear when the heater cools.)
S b	Spa is shut down. The sensor that is plugged into the "B" jack is not working.	If the problem persists, contact your dealer or service organization. (May appear temporarily in an overheat situation and disappear when the heater cools.)
S n	Sensors are out of balance. If alternating with spa temperature, it may just be a temporary condition. If flashing by itself, spa is shut down.	If the problem persists, contact your dealer or service organization.
H L	A significant difference between temperature sensors has been detected. This could indicate a flow problem.	Check water level in spa. Refill if necessary. If the water level is okay, make sure the pumps have been primed. If problem persists, contact your dealer or service organization.
L F	Persistent low flow problems. (Displays on the fifth occurrence of "HL" message within 24 hours.) Heater is shut down, but other spa functions continue to run normally.	Follow action required for "HL" message. Heating capability of the spa will not reset automatically; you may press any button to reset.
dr	Possible inadequate water, poor flow, or air bubbles in the heater. Spa is shut down for 15 minutes.	Water level in spa. Refill if necessary. If water level is okay, make sure the pumps have been primed. Press any button to reset, or this message automatically will reset within 15 minutes. If problem persists, contact your dealer or service organization.
dY	Water detected in heater. (Displays on third occurrence of "DR" message.) Spa is shut down.	Follow action required for "dr" message. Spa will not automatically reset. Press any button to reset.

SKIMMER FILTER CLEANING OR REPLACEMENT OF THE FILTER CARTRIDGE

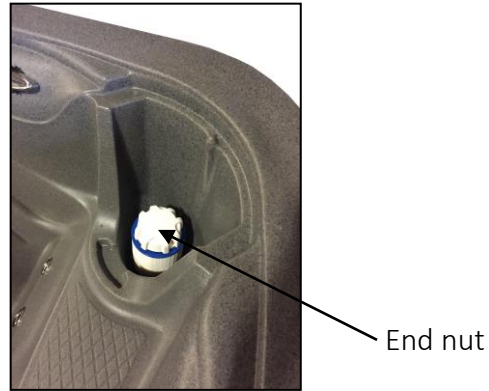

The spa's automatic surface skimmer filter is designed to remove floating debris and contaminants, such as body lotions, by drawing water through a specially formulated filter cartridge element. It is critical that this element be routinely cleaned.

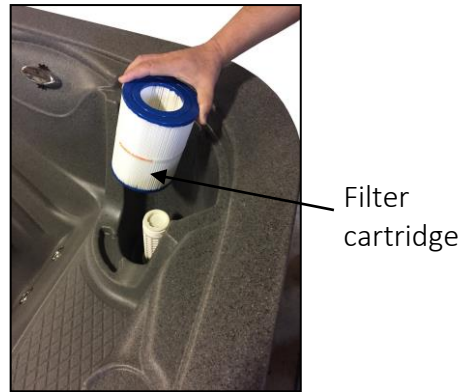
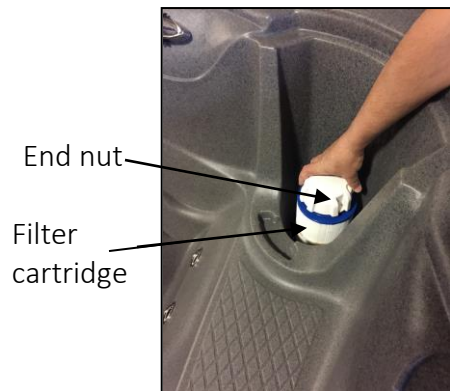

To Clean or Replace the Filter Cartridge

1. Never operate the spa without the filter cartridge in place. It is difficult to remove the filter cartridge while the water is flowing. Also, there is a risk that debris may be drawn into the plumbing system, damage the pump and void the warranty. Disconnect the power.
2. Remove the end nut by turning it counterclockwise.
3. Pull the filter cartridge straight up and out of the skimmer filter.
4. At this point you can install a new filter cartridge and proceed to the next step. To clean the filter cartridge, take it to an area where the run off drains to a sewer drain capable of safely assimilating the water which may contain both unsanitary contaminants and chemical residue. Thoroughly rinse with the high pressure from a garden hose until the filter cartridge is free of dirt and debris.
5. Return the cartridge to the filter well by following steps 1- 4 in reverse order.

Air Injection Venturi Adjustment

Air injection into the jet's water stream is adjusted by turning the venturi dials. Each dial is independent and controls about half of the jets, respectively. Turn them counterclockwise to increase, and clockwise to decrease, the amount of air injected into the jets' water stream.



Adjustable Water Flow Jets

The jet's water flow is adjusted by turning the jet face. Each jet's flow is adjusted independently. Turn the jet face counterclockwise to increase, and clockwise to decrease, the amount of water flow of each jet.



Waterfall Flow Adjustment

Turn the dial counterclockwise to increase, and clockwise to decrease, the amount of water flow of the waterfall.

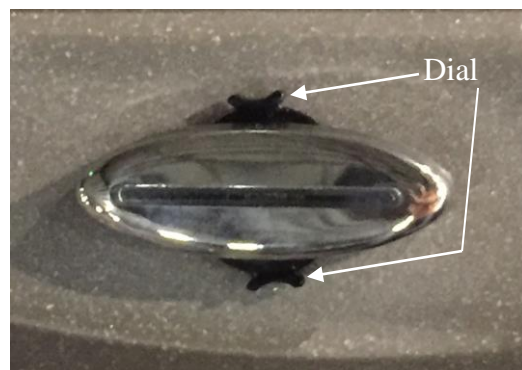

Water Chemistry

Spa water chemistry (or water balance) affects the safety of your equipment as well as the appearance of your spa water. Water balance has five factors: pH, total alkalinity, calcium hardness, temperature and total dissolved solids. The pH is the most critical but total alkalinity and calcium hardness must also be watched closely. Low calcium hardness can lead to corrosion of equipment, while high calcium hardness can lead to scaling, cloudy water and staining. Water temperature should never exceed 104°F (40°C), and total dissolved solids should be kept below 1500 PPM.

Algicidal and sanitizing chemicals are either alkaline or acid. Sodium and calcium hypochlorites are alkaline. Chlorine gas and practically all other dry chlorine spa products are acid. On the market are a number of bromine sanitizers. Bromines are usually preferred since they don't emit a strong chlorine odor.

SEE YOUR SPA WATER EXPERT FOR ADDITIONAL INFORMATION

Damage due to improper chemistry will void warranty

1. Check and adjust water conditions. You must maintain proper chemical balance to insure safe sanitary conditions and to prevent your spa from becoming a breeding place for bacteria. This is done by:
 - A. Test daily and maintain pH between 7.2 and 7.8. Adjust if necessary, above 7.8 use pH decrease, if below 7.2 use pH Increase. Improper pH can damage spa finish, equipment, cause eye irritation and chemical loss. Use dosage according to manufacturer's label.
 - B. Test alkalinity and maintain at 80 ppm to 140 ppm. Adjust if necessary, above 140 ppm use pH Decrease, if below 80 ppm use Total Alkalinity Control. Use dosage according to manufacturer's label.
 - C. Test daily and maintain proper sanitizer level. It's recommended to use bromine sanitizer and maintain bromine at 3.0
5.0 ppm. Typically, two or three bathers relaxing in an average spa with 103°F (39.4°C) temperature will consume all the bromine sanitizer in about twenty minutes. Therefore, prolonged or heavy use may require additional bromine to maintain safe sanitary conditions.
 - D. "Shock" (with a non-chlorine shock) once a week and after each water change. Do not use spa until the bromine residual has dropped to less than 5.0 ppm. NOTE: Improper pH will cause early corrosion to your pump. Corrosion is not handled under any warranty.

SPA MAINTENANCE SCHEDULE

DAILY

Test and maintain pH: Ideal range 7.2 - 7.8b.

Test and maintain bromine: Ideal range 3.0 - 5.0 ppm.

WEEKLY

Test and maintain alkalinity 80 - 140 ppm. Shock with a non-chlorine shock.

Add Spa Clear.

MAINTENANCE

Add defoamer as needed.

Inspect filter cartridge every 2 weeks and clean when needed.

Water Chemistry (Continued)

It is recommended that the spa be drained regularly depending on its size, location and the frequency of use.

1. Clean filter and cartridge periodically according to manufacturer's instructions.
2. Keep the spa covered when not in use to reduce the loss of heat and to keep out leaves, dirt, and other foreign materials from settling in the water.
3. Since the water capacity of your spa is far less than that of a swimming pool, the chemical reaction caused by the presence of one or more persons in the spa is more rapid and pronounced. For these reasons, it is important to frequently check the bromine level, the pH level and total alkalinity of water then add the prescribed chemicals as necessary to maintain the proper chemical balances.
4. If questions or doubts arise regarding quantities and timing of chemical applications to your spa, contact your spa dealer who can assist you in prescribing the correct program for your spa.
5. Store all chemicals in a cool dry place and in such a manner as to prevent contact by children and pets.
6. When adding chemicals to your spa water, add to the center of the spa with the pump operating. Never add chemicals to unheated water as this will affect chemical action.

Replacing the LED Light

1. Turn off power to the spa. Remove the cabinet access panel behind the light and the access panel to the spa control box.
2. Remove the control box cover, locate the light connector and unplug it from the receptacle and remove the cord strain relief by removing the screw.

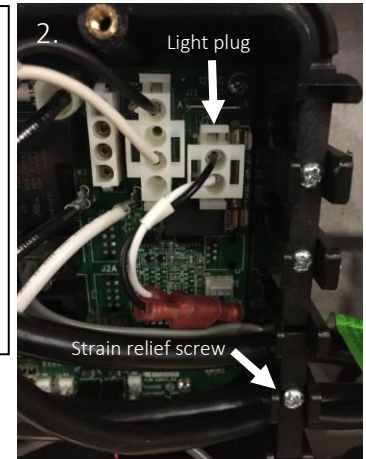
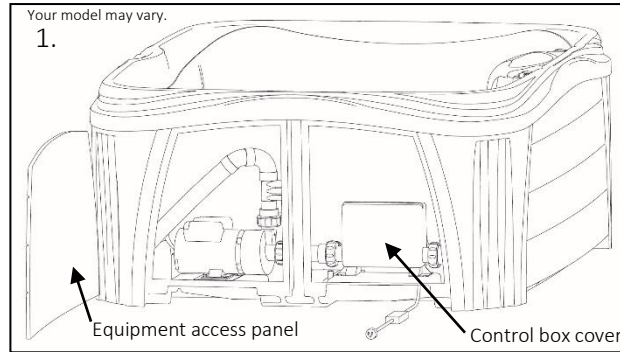

3. Locate and turn the light holder counterclockwise and remove from the wall mounted clear lens.
4. Unplug the daisy chain connectors.
5. While grasping the light holder, turn the light clockwise a quarter turn to free it from the holder.

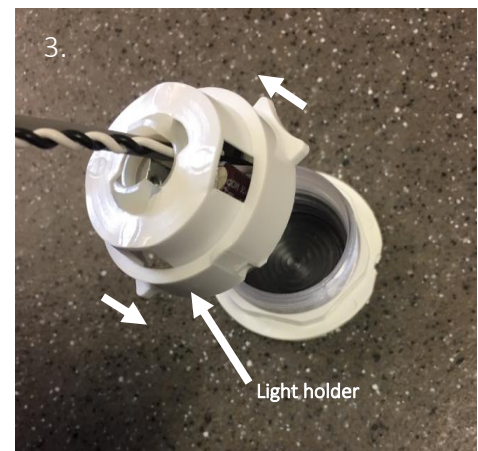

6. Pull the light cord all the way through the holder.
7. Rout the replacement light from the control box to the light lens and install by reversing the previous steps.

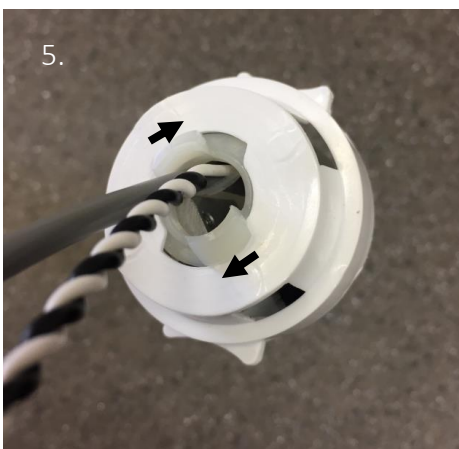

Headrest Installation

Your headrests are designed to not be removed. However, if you need to reinstall the headrest on the spa, follow these steps.

1. Using a Phillips screwdriver, remove the cabinet panel(s) directly behind the headrest location.
2. Locate the two wing nuts and completely remove them turning counterclockwise (fig 10).
3. Remove the two clear threaded fittings and insert their heads into the two outside holes in the back of the headrest (fig 11). Using a hair blow dryer, heating the plastic around the holes first, may help this step, but is not required.
4. Insert the two clear threaded fittings into the corresponding holes in the spa shell (fig 12).
5. Turn the wing nuts clockwise until they pull the headrests against the spa shell. Hand tight is sufficient.
6. Reinstall the panels.

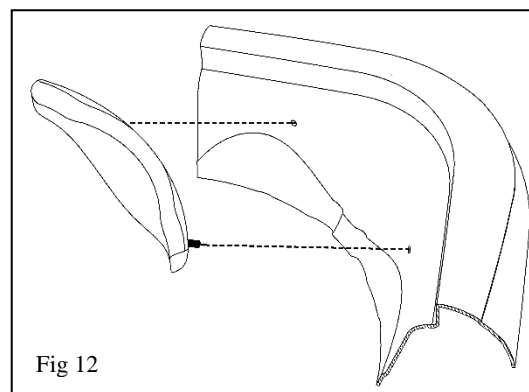
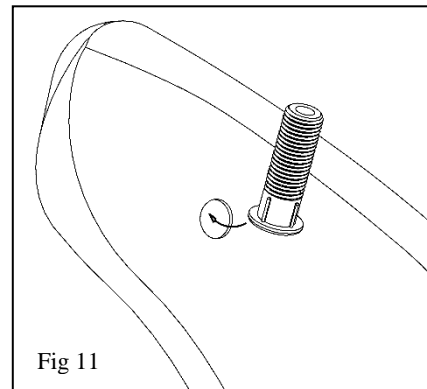
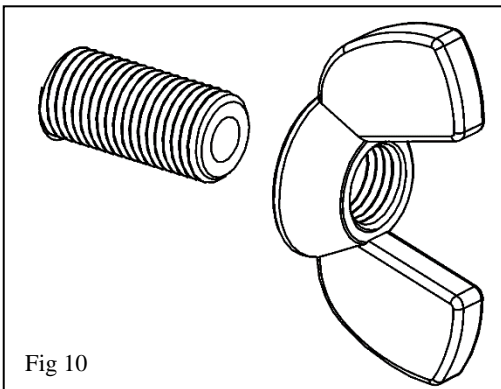

Freeze Protection

DO NOT ALLOW THE SPA TO FREEZE

Caution, any damage caused by improper winterizing will void the warranty. You may want to consider contacting a spa professional for winterizing service.

If the spa is to be stored or transported in temperatures of 32°F (0°C) or lower, it is critical that the unit be fully winterized.

To winterize the spa, follow these steps:

- 1 The spa itself must be completely drained of water. See page 8 for draining instructions.
- 2 The drain valve must be in the open position and the cap removed.
- 3 Drain the pump by removing the pump wet-end drain plug (Fig 13). Leave this plug out until it is time to refill the spa. (Your pump model may vary.)



- 4 The filter cartridge must be removed, dried and stored. See page 20 for instructions for removing the filter cartridge.
- 5 The spa must be inverted (turned upside down) for at least five minutes to facilitate draining of the internal plumbing.

CLEANING YOUR SPA

Do not use cleaners or compounds containing harsh abrasives. Also, avoid using heavy-duty rubbing or buffing compounds. Use a soft liquid cleaner.

CARE OF WEATHERSHIELD COVER

Weather Shield is designed to be easy to maintain. It can be washed or brushed off and rinsed. Proper care and cleaning are important to the life of all fabrics.

FOR NORMAL CARE AND CLEANING. Add 2 ounces of mild soap such as Woolite or Dawn dishwashing liquid to 1 gallon of lukewarm water. Clean the fabric with a "soft bristle brush. Rinse thoroughly with cold water and air dry.

Frequently Asked Questions

- Why does my spa not shut off?** Your spa is designed to run from the time you plug it in, until it reaches your desired water temperature. Once desired water temperature is reached then you can control the functions with the buttons on the top control. For example: On the initial startup the spa will run for up to 18 hours to reach 100°F (38°C). At that point the spa will shut off, and then the spa will maintain your desired temperature settings. Keep in mind that anytime power is disrupted to the spa, the spa will reset itself and run until it reaches the spa's default settings.
- Why does my spa turn on late at night?** The spa is designed to filter every 12 hours. The clock starts the second you plug it in. Recommend unplugging and plugging back in between 7 and 8. This means the spa will come on every 12 hours at the designated time and filter the amount of time you have it set for.
- Why is my spa not heating?** Spas heat at approximately 1.5°F (0.8°C) or more per hour. If your water temperature is 70°F (21°C) when you first fill your spa it will take up to about 20 hours to reach 100°F (38°C). Remember, it is imperative to keep your safety cover on and the air injection dials turned off while heating.
- How many gallons does my spa hold?**

First three characters on rating plate Model No	JS2, SS2, LS2, FS2	JC2, SC2, LC2, FS2	JC3, SC3, LC3, FC3	CS2	CS3	AC2	AC3
Liters	969	1155	1264	1189	1245	1340	1390
Gallons	256	305	334	314	329	354	367

- I see water on the floor. What does this mean?** The cover can accumulate condensation between the seams and run down the sides of the spa. You can verify that water is coming from the cover by squeezing the seam, or by repositioning the cover so that the seam is on a different side. This only occurs when the temperature and humidity are at certain levels.

PURGING THE PUMP

Sometimes after a water change (draining and refilling the spa), or initial start-up of the spa, there is no water flowing from the jets. You may hear the pump operating or even see the shaft of the pump motor turning, but have no water flowing from the jets. In addition to no flow out of the jets, you may even see an error message dr, dY, HH, OH, HL, or LF. All of these error messages can be caused by a lack of water flow. When this happens, there is probably an air-lock in the pump. This air-lock must be purged from the plumbing for the pump to operate normally.

To purge the pump, please follow these steps:

1. Ensure the spa is filled 6 to 8 inches (15 to 20 cm) below the top of the spa.
2. Remove the service panel to expose the water pump. Fig 14

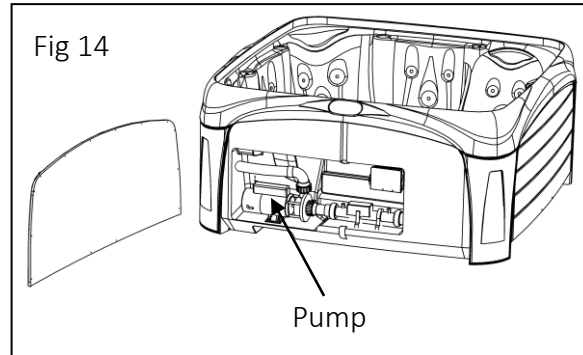

The pipes entering and leaving the pump are connected with large plastic unions. To purge the air from the pump, one of these unions will be slightly loosened.

3. Place a towel under the union to be loosened.
4. Using large pliers, slightly turn the union nut counterclockwise (Fig 15). This will produce a faint hissing sound of the trapped air escaping the pump. This will be followed by a small squirt of water which signals it is time to close the union by turning it back (clockwise). Do not over tighten the union. It is designed to be hand tight.

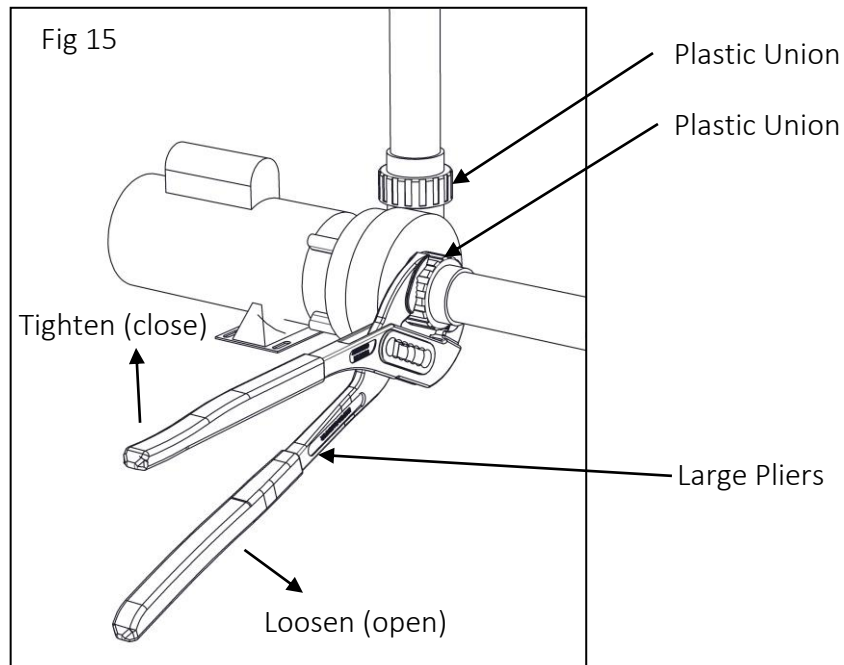

Troubleshooting Guide

SITUATION	PROBABLE CAUSE	ACTION
NO HEAT OR HEAT TOO LOW	Operating while spa cover is open.	Ensure that spa cover is properly closed.
	Dirty filter	Replace or clean filter cartridge. Pg. 20
JETS WON'T COME ON	No power to spa control.	Check the GFCI, circuit breaker and/or disconnect switch.
NO CONTROL DISPLAY OR FUNCTIONS	No power to spa control.	Check the GFCI, circuit breaker and/or disconnect switch.
LOW WATER FLOW	Dirty filter.	Replace or clean filter cartridge. Pg. 20
	Low water level.	Make sure water level in spa is correct.
NO AIR BUBBLES IN JET	Air control valve in the closed position.	Open venturi dials. Pg. 21.
SPA IS LEAKING	Spa drain valve and cap partially open.	Ensure that drain valve and cap are fully closed. Pg. 8
NO SPA LIGHT	Burned out bulb.	Replace bulb. Pg. 24
SLOW WATER DRAIN	Drain valve not fully opened.	Ensure that valve is fully open. Pg. 8
	Dirty filter.	Remove filter cartridge and clean. Pg. 20
	Kinked garden hose	Ensure drain hose is not kinked and is in a downhill direction.
NO WATER FLOW FROM JETS	Air lock in pump	Purge the pump. Pg. 28

Glossary of Terms

Venturi dials

Mounted on the lip of the spa or at the equipment shroud, to induce air to the jets.

BYPASS CHECK VALVE

Prevents water flow stoppage due to dirty filter.

CONTROL BOX

Basically, the brain of the spa. Power is distributed to all functions of the spa, pumps, lights, heat, etc.

DRAIN VALVE

Used in the draining of the spa, looks like an outdoor faucet and fits a standard garden hose.

FILTER

The filter cleans the spa and removes particles and debris and protects the equipment from foreign substances.

FOOTWELL

The bottom of a spa where you place your feet.

GFCI PLUG

The electronic switch installed at the end of the power cord to connect to an electrical wall outlet.

HEATER The thermostatically controlled heater raises the temperature of the water to the desired degree. This is located under the control box in the equipment area.

JETS

The fittings on your spa that direct the flow of water for massaging action.

pH

Stands for "Potential for Hydrogen" This is the term used to describe the acid (low pH) or alkalinity (high pH) condition of the water. The ideal pH for spa water is 7.5.

SKIMMER The skimmer removes surface debris to the filter. The water level in the spa should be kept at the proper range for optimum skimmer operation.

TOP CONTROL PANEL

Mounted on the lip of the spa. The digital panel that controls the spas functions.

Ozone

Your spa may have an ozone generator as standard equipment and will not show in the “option” box of the rating plate. If ozone is an option for your model and you ordered your spa with the optional ozone installed, you can confirm this by viewing the spa’s rating plate. The rating plate is located near the floor and equipment access panel. As shown below, look in the “option” box to confirm the ozonator has been installed. The word “OZONE” will be seen.

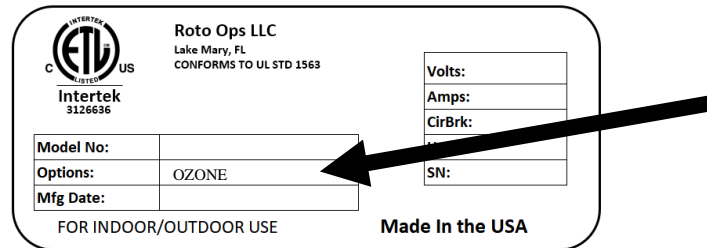

Further to verifying the ozone is installed on your spa. If you look in the equipment compartment you will see a small black or blue box, about 2.6 inches by 3.3 inches x 1.3 inches (6.6cm x 8.4cm x 3.3cm). It will be either strapped to the plumbing or mounted on a wall, as shown below.

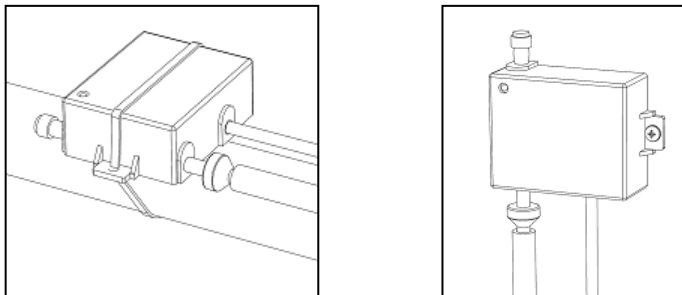

Ozone is an oxidizer used to sanitize water and air. Ozone is created naturally in the environment during thunderstorms. The electric charge created by lightning converts the oxygen in the air into ozone. Your ozonator creates ozone using the same principle. It utilizes a very high electric charge to convert oxygen into ozone. This ozone is then injected into the spa’s water stream and eventually through two of the spa’s jets. These jets will always produce air bubbles (however fine they may be) while the pump is operating and are not controlled by the air injector venturi dials.

The oxygen in the air is normally O₂. That is a molecule consisting of two atoms of oxygen. When exposed to a high electrical charge, a 3rd oxygen atom is added to some of the O₂, forming O₃ (ozone). The weak bond holding the third oxygen atom causes the molecule to be unstable. An oxidation reaction occurs upon any collision between an ozone molecule and a molecule of a substance that can be oxidized, i.e. bacteria, fungi, mould, yeast, viruses, and forms of metals. The weak bond 3rd oxygen atom splits off to these substances, leaving oxygen (O₂) as a by-product. During this oxidation reaction, organic molecules are changed, and dissolved metals are made no longer soluble.

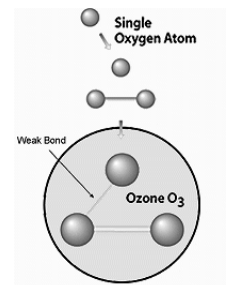

Although ozone is more effective than chlorine, chloramines and chlorine dioxide for inactivation of viruses, Cryptosporidium and Giardia; it dissipates very quickly. For this reason, ozone can only be used as a secondary sanitizer, to enhance the primary sanitizer used to keep your spa safe. You must use a primary source of sanitizer which is always present in the spa water. Please see the Water Chemistry section of the spa owner’s manual for further information about sanitizers.